

MODEL NUMBER:

□ 1660.142 Hand Shower

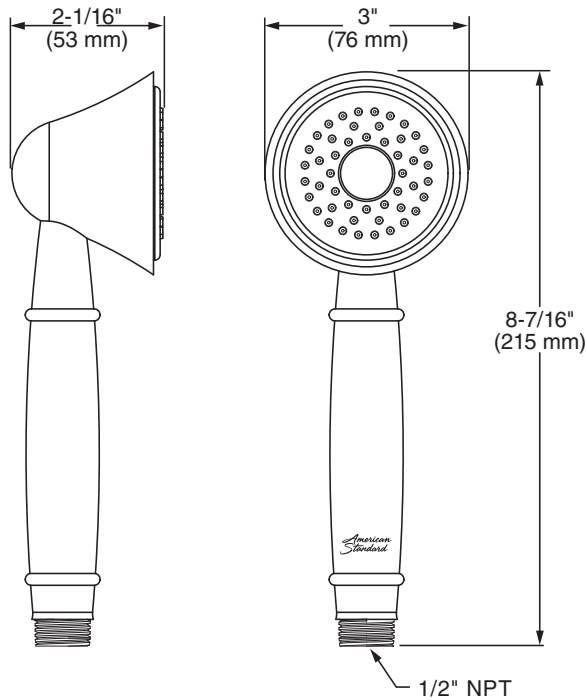

GENERAL DESCRIPTION:

Single Function hand shower. Includes check valve to prevent cross flow of hot and cold water. Easy clean spray nozzles. 1.8 gpm/6.8 L/min. maximum flow rate.

PRODUCT FEATURES:

Single Function: Hand shower provides full spray for coverage of the user.

Easy Clean Spray Nozzles: Easily clean lime and calcium build up. Nozzles will not clog.



SUGGESTED SPECIFICATION

Hand Shower shall include check valve to prevent cross flow of hot and cold water. Fitting shall be American Standard Model # 1660.142.____.





CODES AND STANDARDS

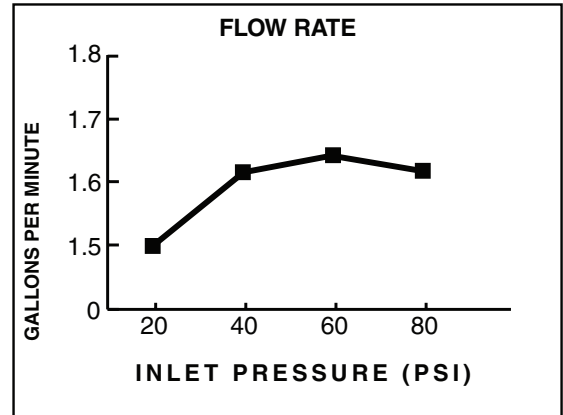



These products meet or exceed the following codes and standards:

ASME A112.18.1
CSA B125.1

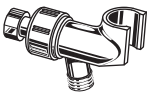

Product Number	Description	Finish Options			
		Polished Nickel	Legacy Bronze	Brushed Nickel	Polished Chrome
		013	278	295	002
1660.142	Hand Shower.				

Hand Shower Accessories	
Product Number	Description
8888.035	59" Metal Shower Hose 
8888.053	79" Metal Shower Hose (Chrome Only) 
1660.400	Vacuum Breaker 
1660.410	Shower Arm Diverter 
8888.096	Shower Arm Bracket 

Hand Shower Accessories	
Product Number	Description
8888.036	Fixed Wall Bracket 
8888.037	Wall Supply 
8888.068	Round Wall Supply 
8888.069	Square Wall Supply 
8888.038	Wall Supply Bracket 