





INSTALLATION BAIGNOIRE AUTOPORTANTE FREESTANDING BATHTUB INTSALLATION



Outils nécessaires / Required tools :

Silicone Silicone	Clé anglaise Wrench
	

Liste de pièces incluses / Parts list included :

Baignoire Bathtub	Tube d'extension Tail piece
	

- 1 Assembler le drain tel qu'illustré.
Assemble the drain as shown.
- 2 Appliquer le silicone à la bride du drain avant de l'insérer à sa place.
Apply Silicone to the drain flange before setting in the drain hole.
- 3 Vissez et serrer le tube d'extention.
Screw and tighten the extension tube.
- 4 Appliquer du silicone au contour de la base de la baignoire avant de la poser.
Apply silicone around the base of the bathtub before installing it.

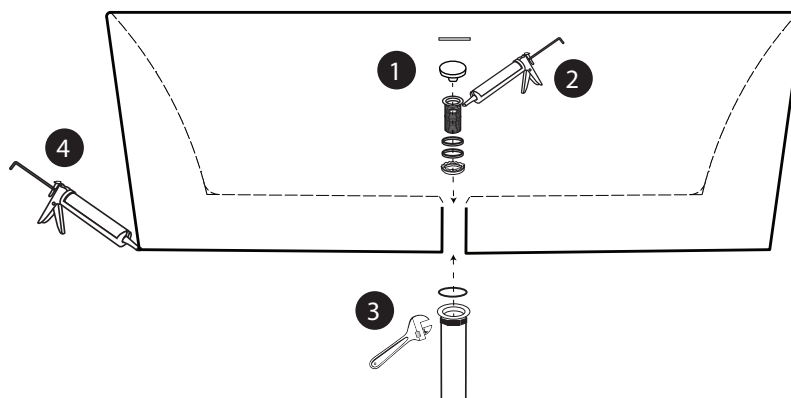

- 5 Insérer le tube d'extension dans le drain du plancher.
Insert the extension tube into the floor drain.

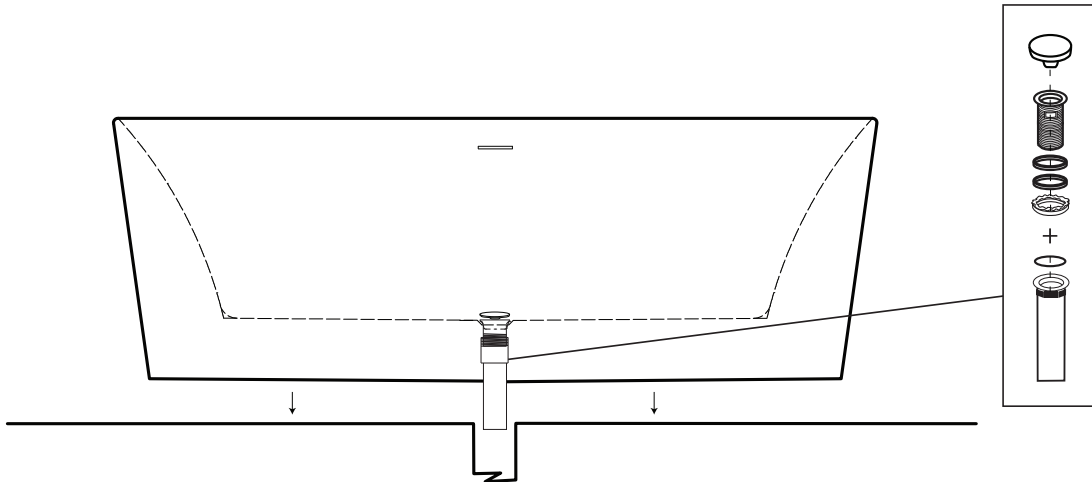

- 6 Remplir la baignoire d'eau et attendre 10 minutes pour voir si il y a des fuites.
Ensuite la vider.
Fill the bathtub with water and wait 10 minutes to see if there are any leaks.
Then empty it.

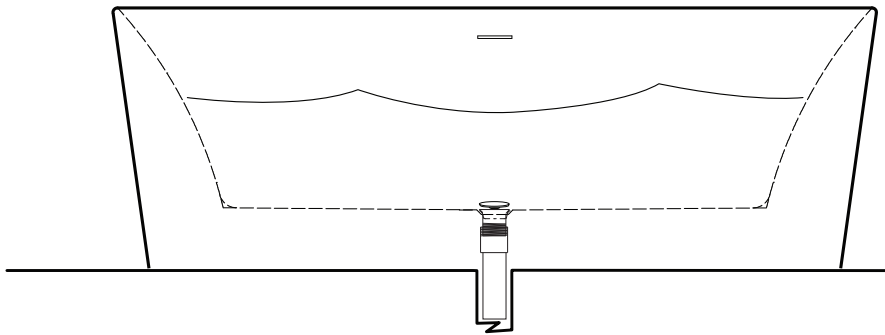

**Attendre 24 heures avant l'utilisation de la baignoire.
Wait 24 hours before using the bathtub**