

# SOUS PLAN / UNDER MOUNT



## ZZ276UB

### Dimensions / Dimensions

31 7/8" x 20 1/8" x 9" / 7" (809 x 510 x 229 / 178 mm)

### Détails / Details

Épaisseur / Thickness: 20 G

Larg. min. d'armoire / Min. cab. size: 36" (915 mm)

### Accessoires inclus / Included accessories

Crépine-panier / Basket Strainer: BP37

Attaches et Gabarit de coupe / Clips and Cutout template



<p><b>GRADE 304</b></p>	<p>SEUL LACIER INOXYDABLE DE QUALITÉ SUPÉRIEURE EST UTILISÉ POUR FABRIQUER LES ÉVIERS ET ACCESSOIRES NAUTIKA®</p> <p>ONLY SUPERIOR QUALITY STAINLESS STEEL IS USED FOR NAUTIKA® SINKS AND ACCESSORIES</p>	<p>ÉVIERS/SINKS CAN/CSA-B46</p> <p>NAUTIKA CERTIFIED</p>	<p>CRÉPINES/STRAINERS CAN/CSA-B125</p> <p>NAUTIKA CERTIFIED</p>	<p>TOUTES LES COMPOSANTES NAUTIKA® SONT CERTIFIÉES</p> <p>ALL NAUTIKA® COMPONENTS ARE CERTIFIED</p>
	<p>NAUTIKA CERTIFIED</p>			

### Accessoires vendus séparément / Accessories sold separately

Grille(s) de fond / Bottom Grid(s): GR054, GR055

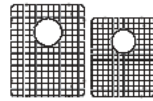

Crépine-panier / Basket Strainer: BP38



Tamis / Colander: COL001B



Tamis / Colander: COL003B



Panier ajustable / Adjustable basket: GR037

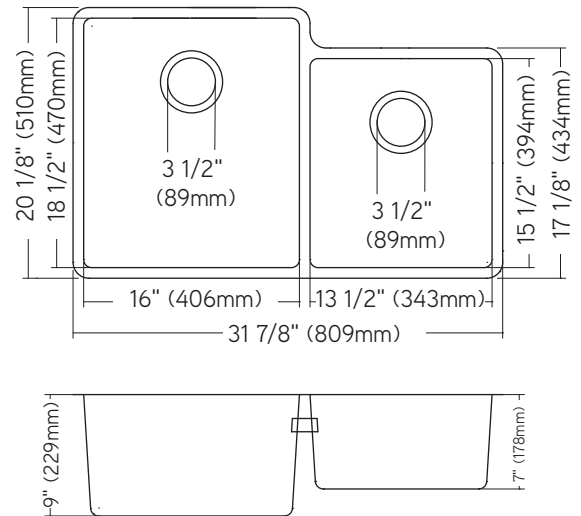

### Vos notes personnelles / Your personal notes

---

---

---

---

---

---

---

---

---

---

### GARANTIE LIMITÉE NAUTIKA OFFRETE À L'ACHETEUR - ÉVIERS À USAGE RÉSIDENTIEL (extrait du texte complet de la garantie disponible sur nautika.ca)

Les évier Nautika sont garantis contre les défauts de matériaux ou de fabrication, dans les conditions d'usage domestique normales pour lesquelles ils ont été conçus, cette garantie reste en vigueur tant que vous restez propriétaire de votre évier.

### NAUTIKA LIMITED BUYER WARRANTY - RESIDENTIAL SINKS (excerpt from the complete warranty text available at nautika.ca)

Nautika sinks are guaranteed against defects in material or workmanship for any normal domestic purpose for which it is intended for as you own your sink.